

Installation Manual

AUDI A3 5DR
AU-A3-5-B



COMPONENTS INCLUDED

SHADES

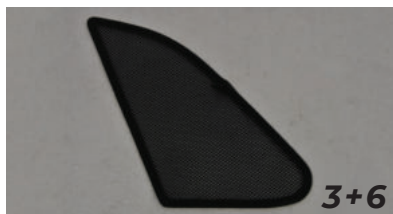
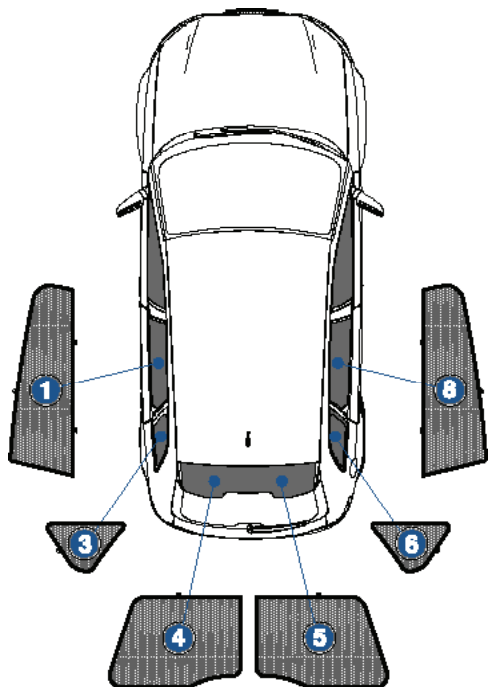

FIXING CLIPS



CL-M01 x 2



CL-M04 x 2



CL-M13 x 6



CL-M14 x 1

Side Shade Installation

AUDI A3 5DR
AU-A3-5-B

COMPONENTS NEEDED:



STEP #1

ATTACH CLIPS ON SHADE EDGES



STEP #2

POSITION THE SIDE SHADE

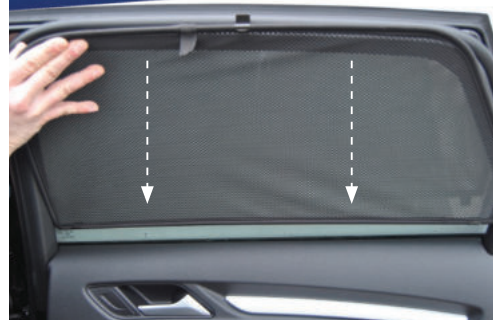

STEP #3

INSERT CLIPS INSIDE WEATHERSTRIP

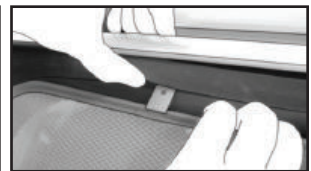

STEP #4

ENSURE SECURELY FITTED IN PLACE

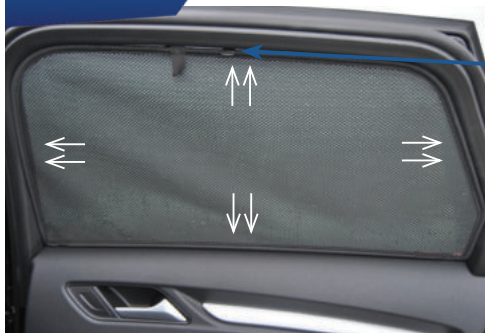

CAR
SHADES

Quarter Light Shade Installation

AUDI A3 5DR
AU-A3-5-B

COMPONENTS NEEDED:



STEP #1

ATTACH CLIPS ON SHADE EDGES



STEP #2

INSERT CLIPS BEHIND INTERIOR TRIM



STEP #3

ENSURE SECURELY FITTED IN PLACE

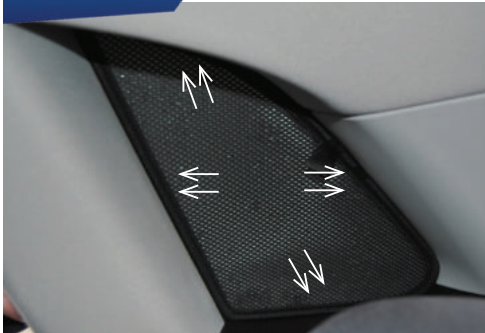

Rear Shade Installation

AUDI A3 5DR
AU-A3-5-B

COMPONENTS NEEDED:

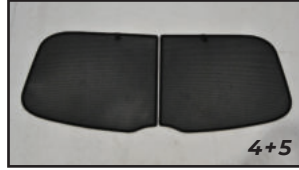

CL-M01 x 2



CL-M14 x 1

STEP #1

ATTACH CLIPS ON SHADE EDGES



STEP #2

POSITION THE REAR SHADE

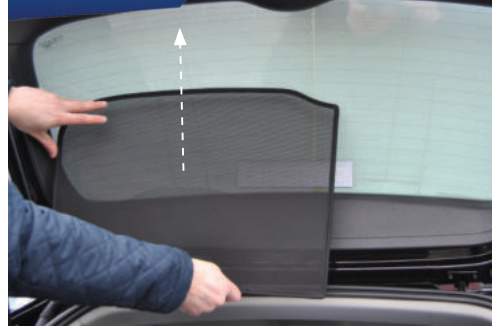

STEP #3

INSERT CLIPS BEHIND INTERIOR TRIM



STEP #4

REPEAT THE PROCESS ON OTHER SHADE



STEP #5

ENSURE SECURELY FITTED IN PLACE



CAR
SHADES