

MOTUS

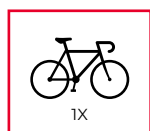







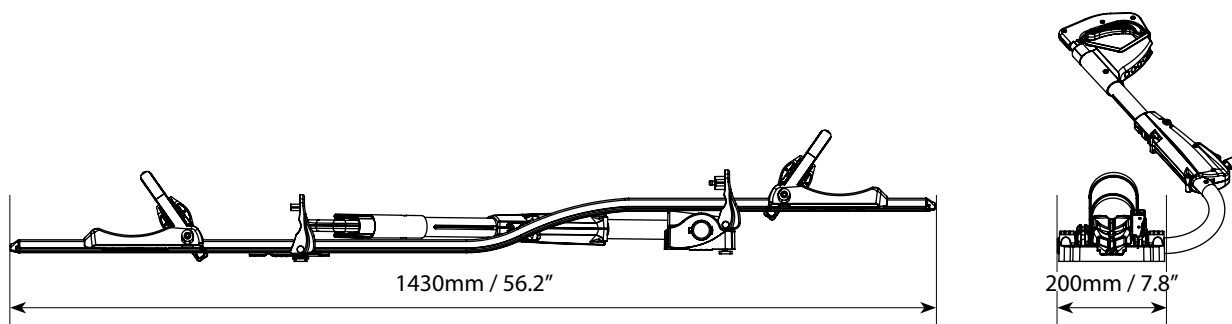

Portabici da tetto con struttura in alluminio e braccio ferma telaio regolabile. Dotato di sistema antifurto per carico e portabici.

Roof mounted bike carrier with aluminium structure and adjustable frame arm holder. Equipped with anti-theft system for both the bike rack and the load.

Art.000145700000



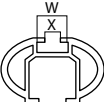







Art.	000145700000
 Peso prodotto Product weight	3,8kg/8.3lb
Materiale Material	Alluminio, acciaio, plastica Aluminium, steel, plastic
 Portata massima Max load	max 20kg/44lb
 Antifurto portabici Anti-theft for the bike rack	✓
 Antifurto bici Anti-theft for the bike	✓
 Sistema di montaggio alle barre Fixing system to the roof bars	 T-system X: min 6,5mm/0.3" W: 20mm/0.8" Optional kit 000146000000
	x1
E-bike	x
Fat bike	x

Product logistics



COMPATIBILITÀ BICI BIKE COMPATIBILITY

Art.				
MOTUS	 min: 25mm/1" max: 80mm/3.1"	 min: 25mm/1" - max: 80mm/3.1"	min 22" max 29"	max 75mm/3" max 1200mm/47.2"

F.lli Menabò s.r.l.

Via 8 Marzo 3,
42025 Cavriago (RE), Italy
customer@flli-menabo.it
www.menabocaraccessories.com