

# **INSTALLATION, USE, AND MAINTENANCE MANUAL**

---

## **CARGOBLOCK® ND**

---

**Cargo Area Door Protection for  
Commercial Vehicles**

EAN Code **8056814560539**

product Code **0001070001102**

Application:

**FIAT Doblò**

**OPEL Combo versione precedente**





**Fiat Doblò**



**Opel Combo versione precedente**

## A - PREMISE

### Objective of the Manual

This manual aims to provide detailed guidelines and essential information for the correct installation of the *CargoBlock ND* anti-theft system on the vehicle. It is recommended to follow all the procedures outlined meticulously, as they are crucial to ensuring a quick and optimal installation.

### Warning

Before proceeding with the installation, it is essential to verify that the rear and side doors are properly aligned and that the images in this manual match those of the vehicle on which the system is to be installed. *ST Automotive* disclaims any responsibility for damages to the vehicle resulting from incorrect installation or failure to follow the instructions.

## B - GENERAL INSTRUCTIONS

### Installation of CargoBlock ND

The installation of *CargoBlock ND* has been rigorously tested on vehicles following the assembly instructions outlined in the attached manual.

### Warranty Registration

To activate the product warranty, it is mandatory to register on the website: <https://web.starblock.it/garanzia-prodotto/>

## C - CARATTERISTICHE TECNICHE

**CargoBlock ND** rappresenta la protezione innovativa per le porte dei vani di carico dei veicoli commerciali, progettato per un'installazione senza fori o modifiche strutturali. Realizzato con piastre in acciaio inox preformate e pre-forate, assicura la massima affidabilità.

Grazie al suo design avanzato e alla tecnologia all'avanguardia, **CargoBlock ND** è pratico e semplice da installare. Viene fornito con piastre di fissaggio dedicate per ogni modello di veicolo, consentendo l'installazione sui punti di fissaggio originali delle serrature, senza necessità di ulteriori fori o modifiche.

**CargoBlock ND** è dotato della serratura proprietaria **StarBlock®**, che incorpora tecnologia avanzata e una chiave a profilo induplicabile.

## D – PACKAGE CONTENTS

- 1 Welcome kit
- 2 Reflective sticker sets for rear and side doors
- 2 Window decals
- 2 Keys + 1 emergency key
- 2 Keychains



### Accessories:



1 M8x25 Stud



1 M6x25 Stud

### Equipment required for installation:



Torx key size 30



**1 - Left side rear door plate**



**2 - Right side rear door plate**



**3 - Sliding side door plate**

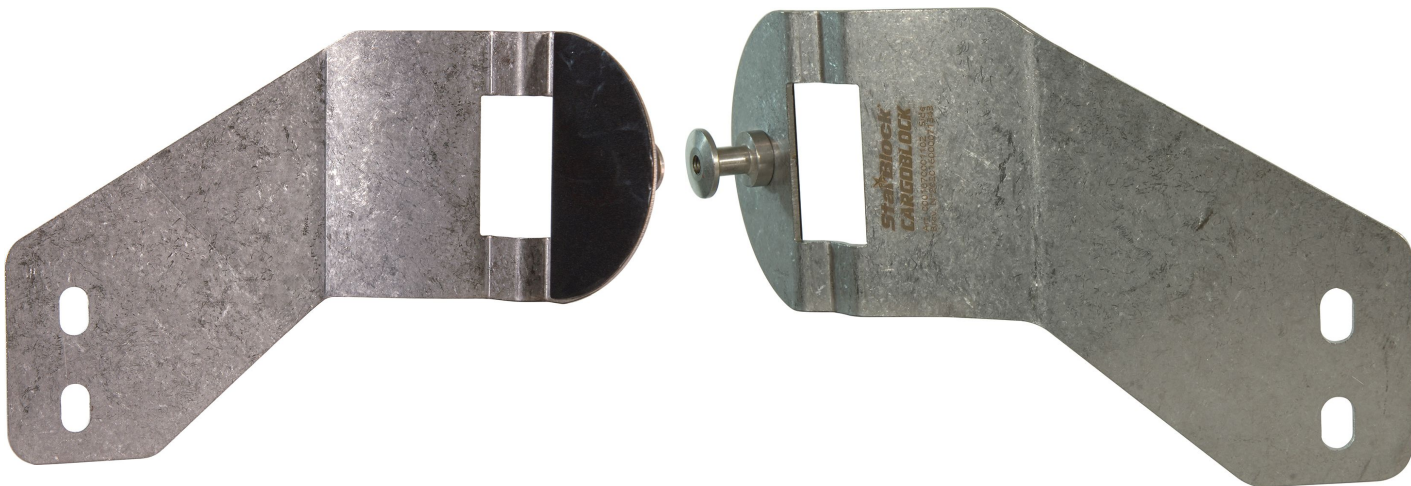

**4 - Side door pillar plate**

## E – INSTALLATION GUIDE [Rear Door]



Remove the Torx screw that secures the lock.

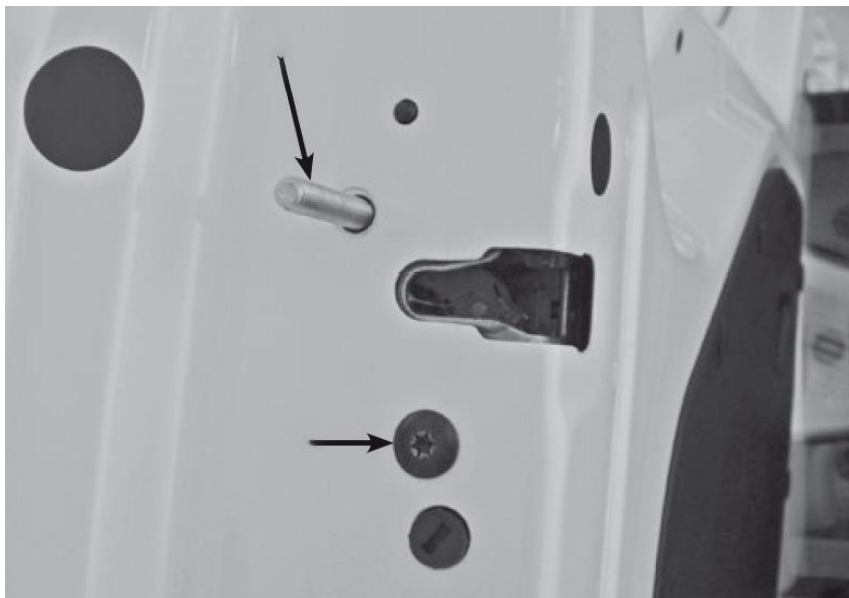

Screw in the supplied stud to prevent the lock from detaching; then, unscrew the Torx screw that secures the lock.



## E – INSTALLATION GUIDE [Rear Door]



Position the plate (as shown in the image) in line with the lock mounting holes.



Secure the plate with the supplied Torx pin, avoiding tightening it fully to allow for the final adjustment. Remove the stud and re-screw the supplied Torx pin. Finally, tighten all the pins.

## E – INSTALLATION GUIDE [Rear Door]



Unscrew the two Torx screws that secure the hook.

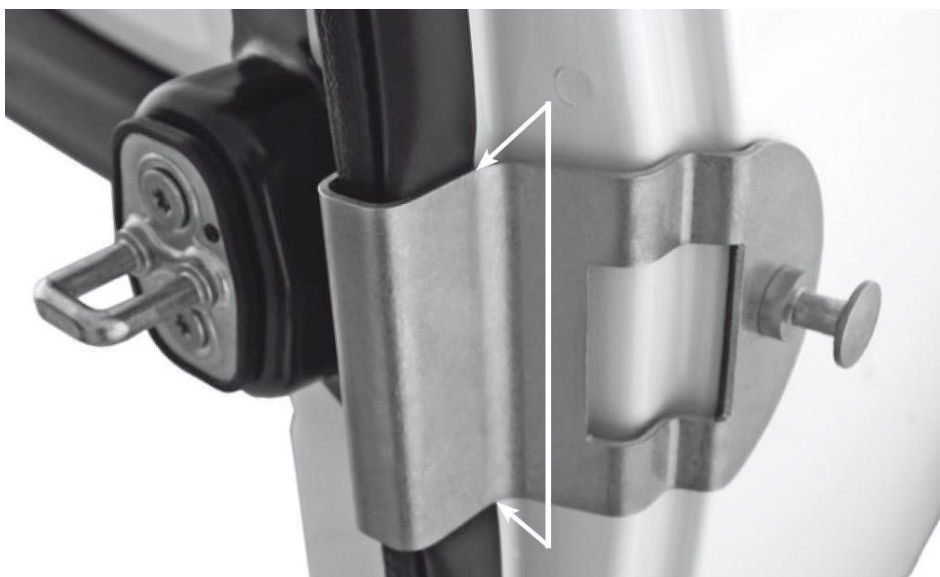

Position the supplied plate in line with the hook mounting holes. Ensure that during the plate fastening process, the gasket is not compressed between the edges of the door and the plate

## E – INSTALLATION GUIDE [Rear Door]



Secure the plate with the Torx pins that were previously unscrewed, avoiding tightening them fully to allow for the final adjustment.



Bring the two doors together and check that the plates are aligned.

## E – INSTALLATION GUIDE [Rear Door]

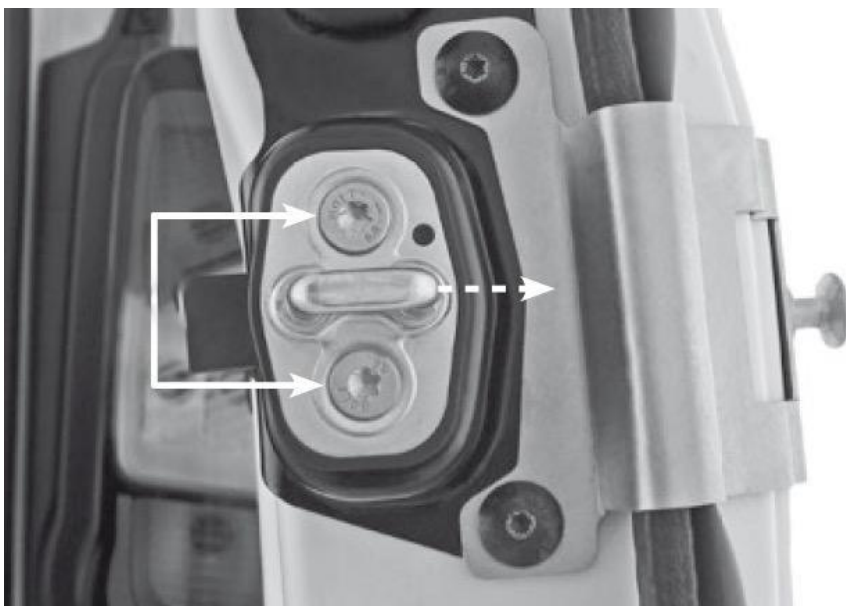

If the lock does not close properly, unscrew the two Torx screws that secure the hook and move it outward (as indicated by the dashed line), adjusting it until the door closes correctly.

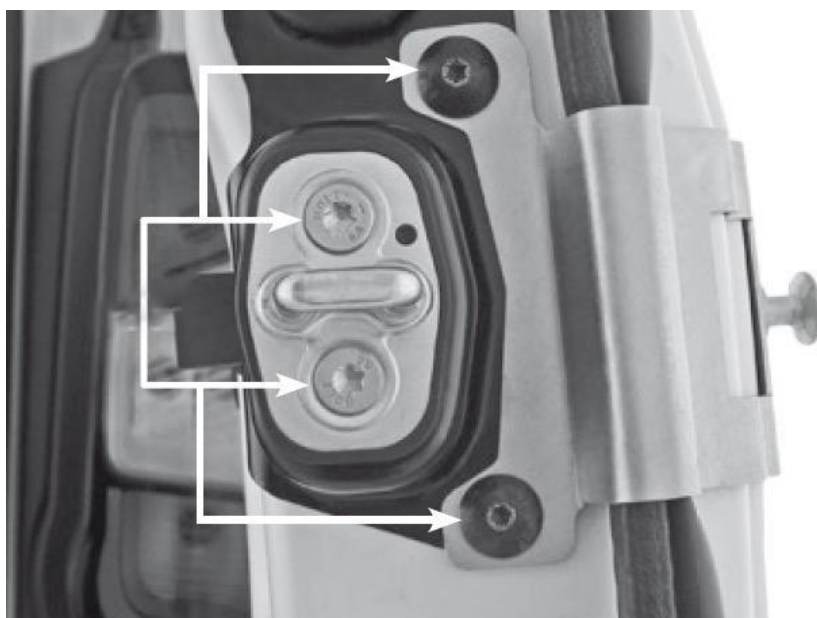

Finally, tighten the four screws that secure the hook and the plate.

## E – INSTALLATION GUIDE [Rear Door]



Completed installation of the *CargoBlock ND* on the rear door of the vehicle.

## E – INSTALLATION GUIDE [Side Door]

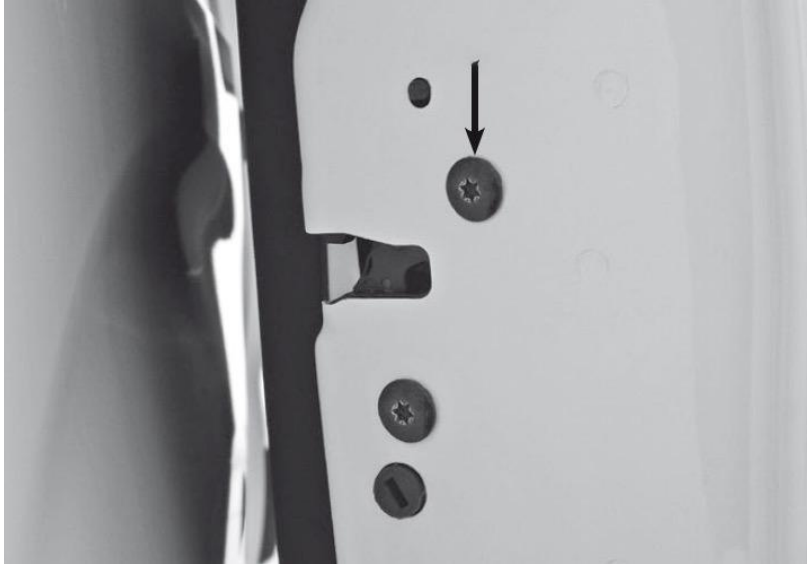

Remove the Torx screw that secures the lock.

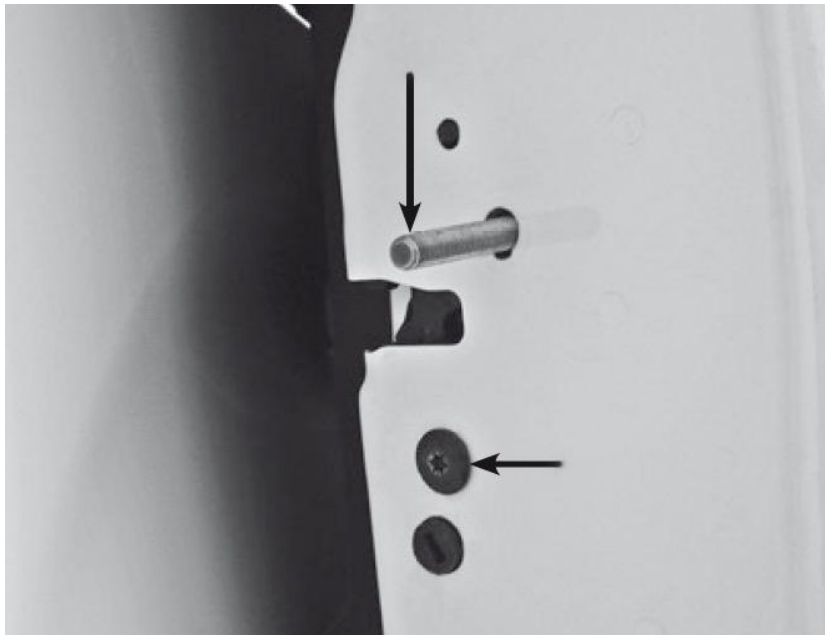

Screw in the supplied stud to prevent the lock from detaching; then, unscrew the Torx screw that secures the lock.

## E – INSTALLATION GUIDE [Side Door]



Position the side door plate (as shown in the image) in line with the lock mounting holes.



Secure the plate with the supplied Torx pin, avoiding tightening it fully to allow for the final adjustment. Remove the stud and re-screw the original Torx screw; finally, tighten all the pins.

## E – INSTALLATION GUIDE [Side Door]

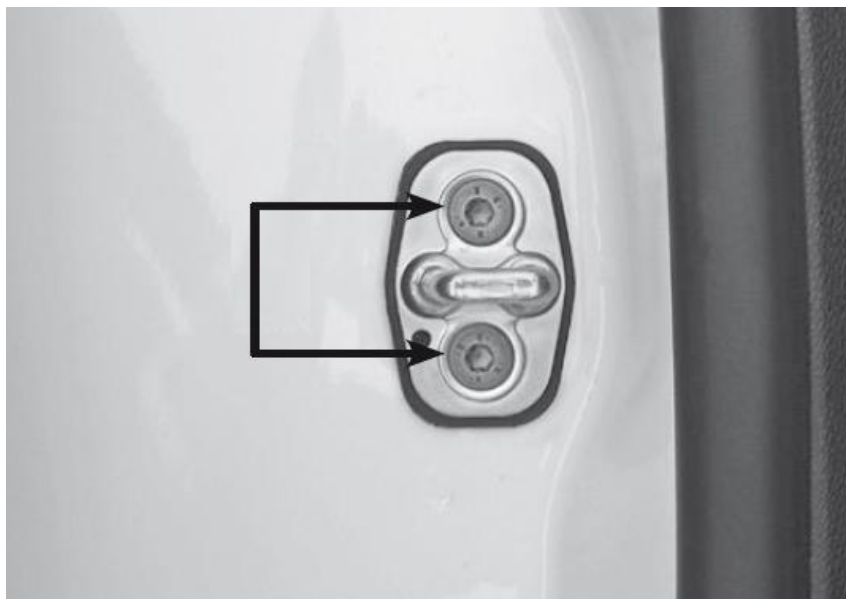

Unscrew the two Torx screws that secure the hook.

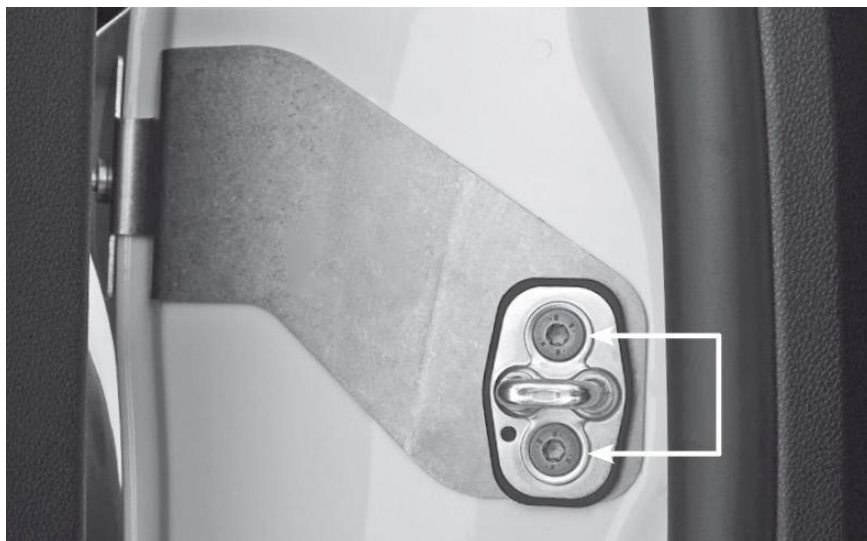

Position the supplied plate in line with the hook mounting holes and simultaneously place the hook onto the plate. Secure them with the original screws, avoiding tightening them fully to allow for the final adjustment of the plate and hook.



## E – INSTALLATION GUIDE [Side Door]



Partially close the sliding door and ensure that the plates are aligned. Once the correct alignment is verified, proceed with tightening all the Torx screws.

## E – INSTALLATION GUIDE [Side Door]



Completed installation of the *CargoBlock ND* on the side door of the vehicle.

## F – USE AND MAINTENANCE

### HOW TO USE CARGOLOCK

1. **Opening CargoBlock ND:** Insert the key into the lock of the rear or side doors. Either side of insertion is fine. Turn the key 90° clockwise. In this position, the key cannot be removed from the lock.
2. **Closing CargoBlock:** Close the vehicle doors completely. Turn the key counterclockwise. Then, remove the key from the lock.

### MAINTENANCE OF CARGOLOCK

1. **Periodic Cleaning:** Remove any dust buildup from the product and the lock. Apply a dry lubricant spray to the lock and mechanism.
2. **Maintenance Frequency:** It is recommended to perform maintenance every six months. Perform maintenance more frequently if used in particularly dusty, sandy, or dirty environments.
3. **Additional Protection:** If the vehicle is used on muddy roads, it is recommended to use the anti-mud device to protect the lock.



**ST Automotive Srl**  
Ss 96 Km 119  
70026 Modugno (BA)  
T.+39 080 2143503  
[info@starblock.it](mailto:info@starblock.it)

